

SIMPLE ORIGAMI FOR CUB SCOUTS AND LEADERS

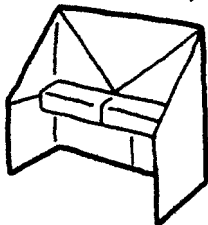
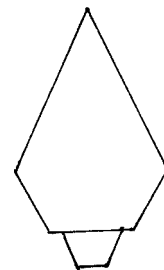
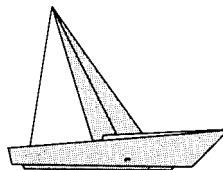
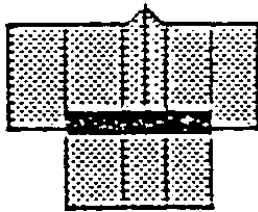
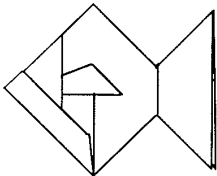
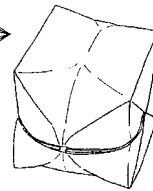
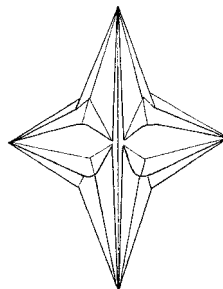
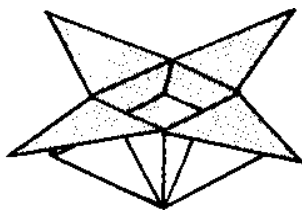
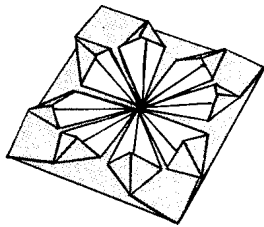

Sakiko Wehrman
(408) 296-6376
pwehrman@ihot.com

ORIGAMI means paper folding. Although it is best known by this Japanese name, the art of paper folding is found all over Asia. It is generally believed to have originated in China, where paper-making methods were first developed two thousand years ago.

All you need is paper (and scissors, sometimes). You can use any kind of paper. Traditional origami patterns use square paper but there are some patterns using rectangular paper, paper strips, or even circle shaped paper. Typing paper works well for all these projects. Also try newspaper, gift-wrap paper, or magazine pages. You may even want to draw a design on the paper before folding it. If you want to buy origami paper, it is available at craft stores and stationary stores (or pick it up at Japan Town or China Town when you go there on a field trip). Teach the boys how to make a square piece from a rectangular sheet. Then they will soon figure out they can keep going, making smaller and smaller squares. Then they will be making small folded trees or cups!

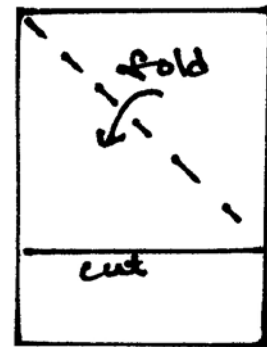

Standard origami paper sold at a store is 15cm x 15 cm (6"x6") but they come as small as 4cm (1.5") and as large as 24cm (almost 9.5"). They come in different colors either single sided or double sided. They also come in different patterns, varying from traditional Japanese patterns to sparkles.

When you make an origami, take your time. Neatness counts! Also unless otherwise noted in the instructions, make your creases nice and sharp.

Here are some relatively simple patterns that boys can make. I tried to include those that the boys can play with or use afterward. With other patterns, use them in mobiles, ornaments, invitation notes (for Blue and Gold, for example), greeting cards, thank you notes, etc. It's much more fun if you can use what you make.

Some patterns are "progressive," using another pattern as the starting point. I put them next to each other so it is easier to refer to the base patterns.

I also included the Bobcat Trail Game, which uses the pattern for a "Cootie Catcher" or "Fortune Telling Game."

PROJECTS USING SQUARE PIECES OF PAPER

Samurai Helmet	4
Goldfish	5
Fish	6
Whale	7
Boat	8
Sailboat	8
Catamaran, Windmill, Sailboat, Trick Boat	9 - 10
Coaster	11
Tree	12
Pecking Bird	13
Butterfly	14
House	15
Upright Piano	16
Coin Purse (Candy Bag), Hat	16
Lantern	17
Rowboat	18
Balloon	19
Mystery Triangle	20
Cup	21
Box	22
Candy Dish	23
Star	24
Bobcat Trail Game	25

PROJECTS USING RECTANGULAR PIECES OF PAPER

Jumping Frog	26
Magic Book	27
Shirt	28
Kimono	29

PROJECTS USING PAPER STRIPS

Chinese Lucky Star	30
Puffy Heart	31

SAMURAI HELMET

Make this out of newspaper and wear it.

1. Fold paper into triangle.
2. Fold left and right corners down.
3. Fold top layer upward.
4. Fold top corners outward.
5. Fold bottom corner of top layer up as shown.
6. Fold lower edge of triangle up along base.
- 7a. Tuck the bottom triangle inside the helmet.

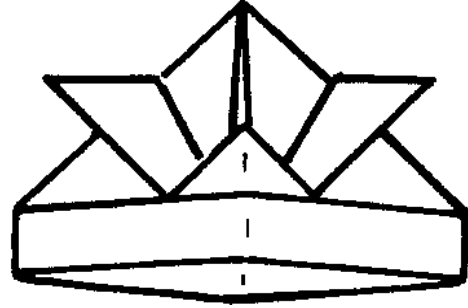

VARIATION: (This keeps the helmet in shape better)

- 7b. Fold left and right corners back.
8. Fold bottom flap back.

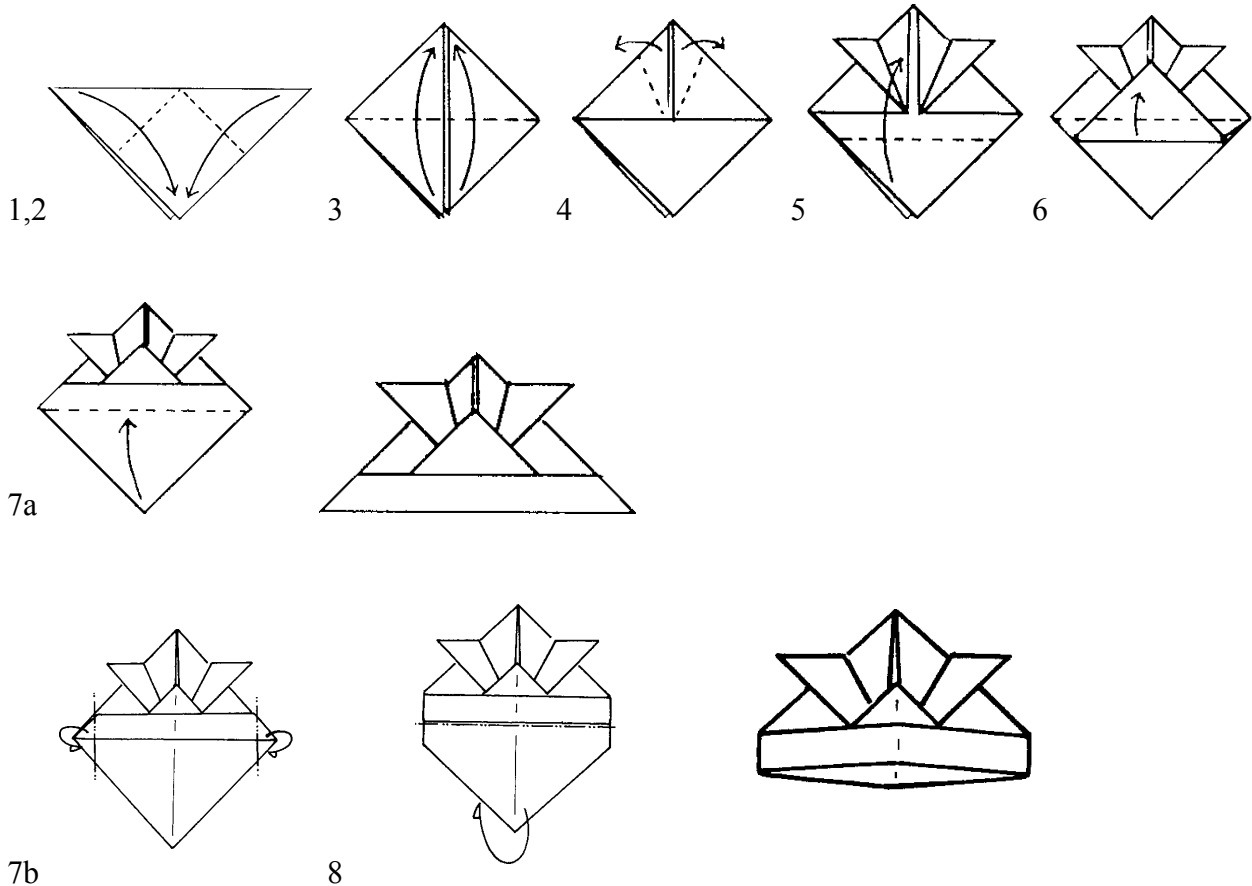

GOLDFISH

This pattern starts with Step 6 of the SUMURAI HELMET.

7. Cut part way from each end as shown.
8. Fold the bottom flap to the back.
9. Open up the "helmet."
10. Make a fold. Crease by folding to each side.
11. Take the top layer and fold it inside out along the crease line.

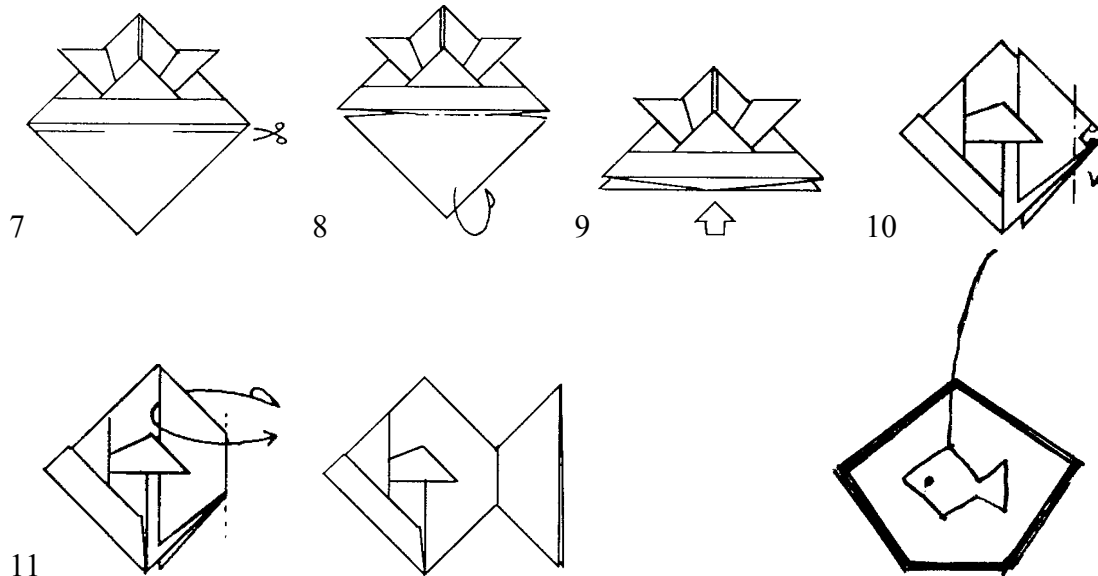

Goldfish Mobile:

Make a goldfish using a sheet of origami paper or 6"x6" paper with a different color on each side. With a needle, attach a piece of string on the goldfish. Make a large knot or tape the end inside the fish. Arrange five craft sticks in a pentagon. Glue ends leaving one joint unglued. Arrange the fish so it is placed in the middle of the pentagon. Place the thread between the two unglued sticks and glue them together.

NOTES:

1. It is not easy for young boys to glue five sticks in the shape of pentagon. Ahead of time, make a template for the pentagon on a piece of cardboard. This way, boys can place their craft sticks on the pattern.
2. Low temperature glue gun works best for this project.

Goldfish Card

Add google eyes or a gem. Draw stripes on the fin and tail if you wish. Mount it on a folded card.

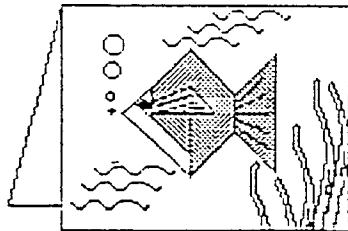

(Idea and drawing of the card from RAFT handout)

FISH

1. Fold paper into triangle. Unfold.
2. Fold top and bottom corners in to center line. Turn over.
3. Fold in half by bringing **a** to **b**.
4. Turn over
5. Open the corner by sliding a finger inside top flap.
6. Do the same on the other flap.
7. It should look like this.
8. Open.
9. Fold away part of the bottom layer.
10. Fold in half.
11. Fold down fins.
12. Fold up tail. You may want to glue the tail onto the other side so it stays up.

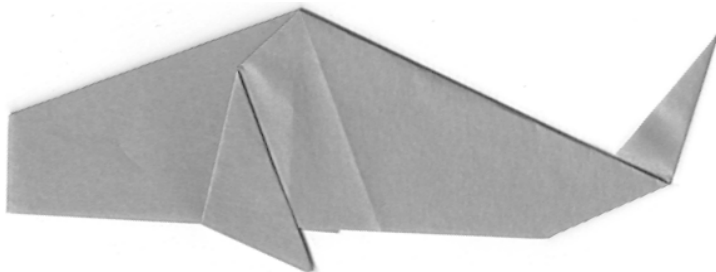
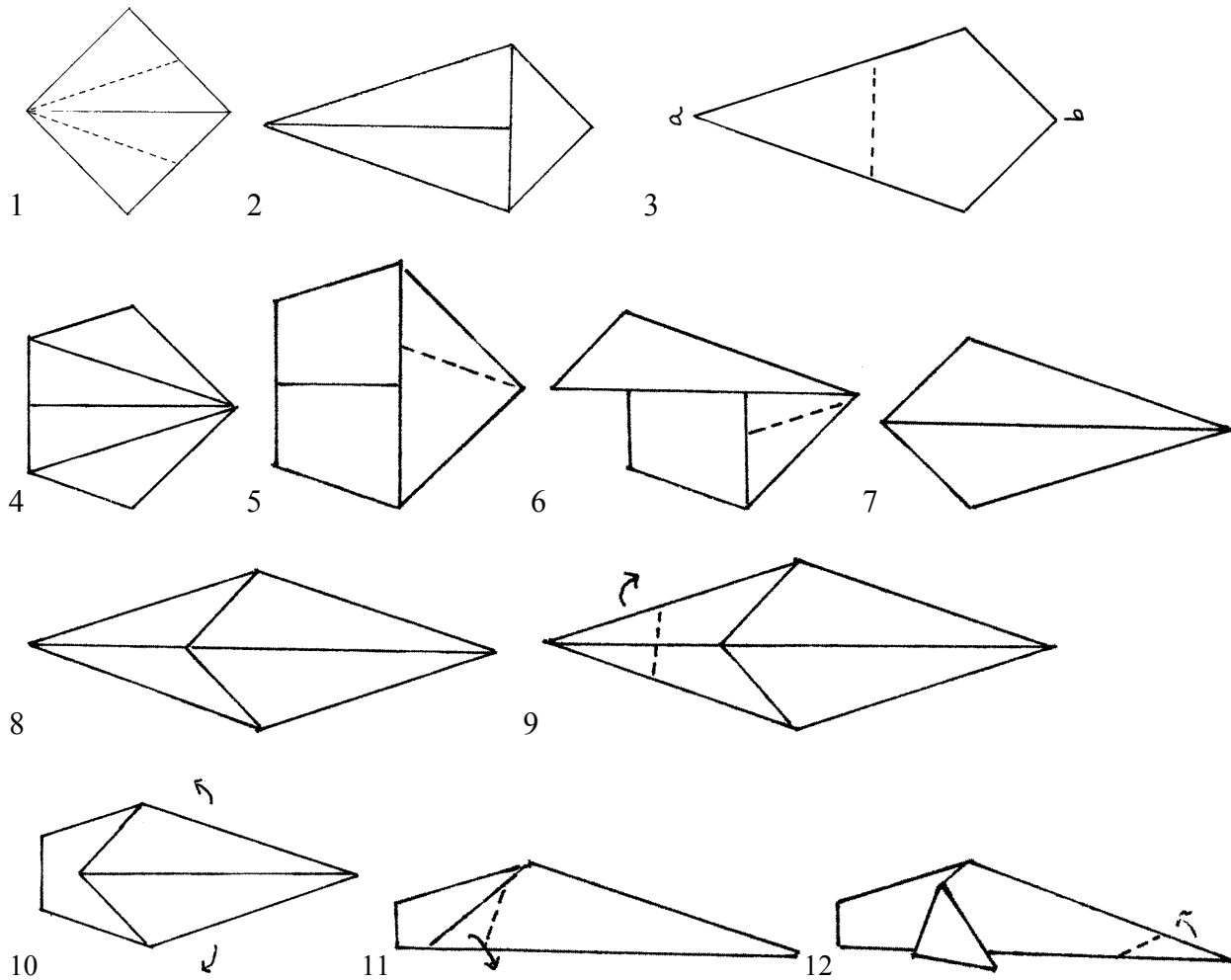

WHALE

Start with Step 8 of the FISH

9. Turn over.
10. Fold in the top and both sides.
11. Fold in half.
12. Fold down the fins and fold up the tail.
13. Cut apart the folded end of the tail (c to d). Spread the tail.

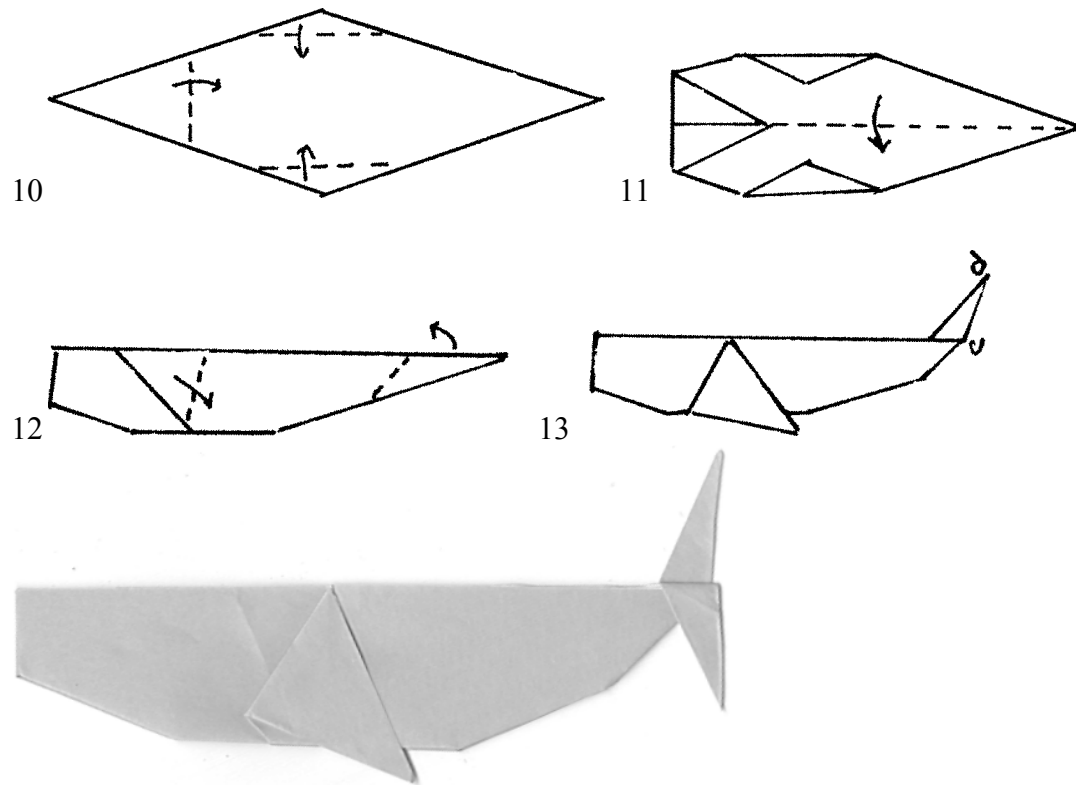

Sea Mobiles

Make fish, whale, and boats in various sizes and colors. Use a dab of glue on each creation to keep its shape. Hang them from a wire coat hanger, a few sticks, or straws. Secure string on coat hanger, sticks or straws with small amount of glue so it won't move. It is very frustrating if boats and fish get all bunched up and unbalance the mobile.

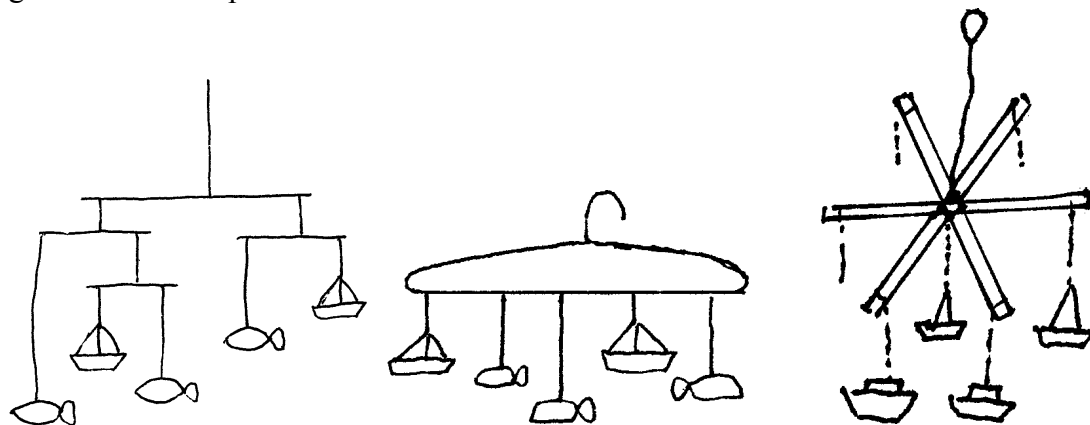

BOAT

Think of different types of boats. Make sailboats, tankers, and passenger ships. While folding, make up stories about the boats.

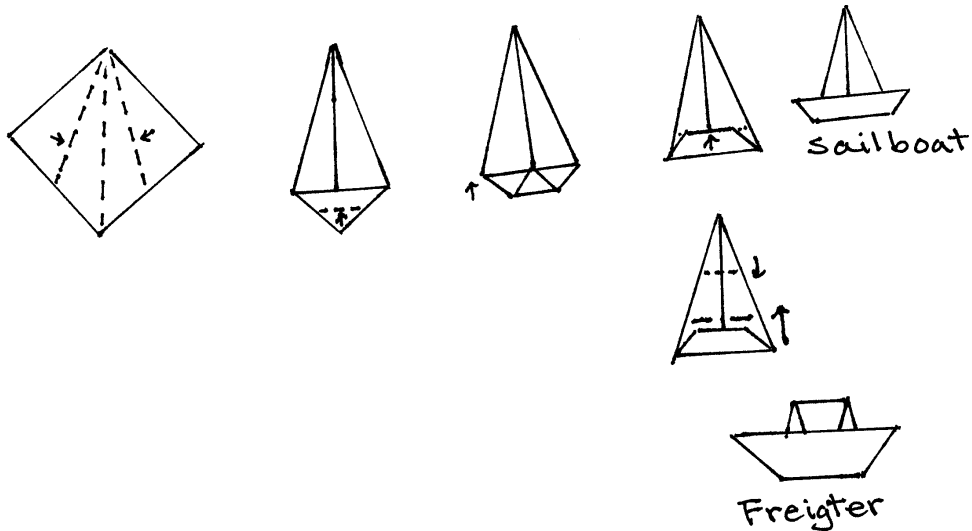

SAILBOAT

This boat can stand on its own. I have used this as a place marker at a Blue and Gold Banquet once. Boys made one for each member of their family and wrote their name on the hull. You may want to put a dab of glue on the back of the hull to keep it in place.

1. Fold in half. Fold back the top layer.
2. Fold the top in half.
3. Bring up the bottom.
4. Fold away in half.
5. Turn over. Fold down.
6. Back view.

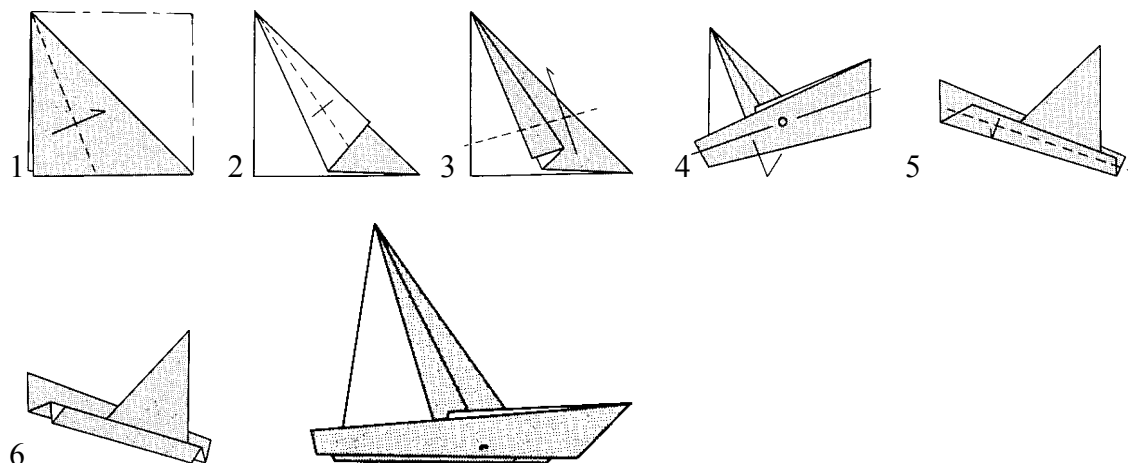

CATAMARAN, WINDMILL, SAILBOAT, TRICK BOAT

This is a series of shapes you can make from the same base.

CATAMARAN

1. Fold in half. Unfold. Fold the sides to center line.
2. Fold back in half.
3. Fold in half and unfold.
4. Make diagonal creases.
5. Open along the crease lines and press.
6. It should look like this. Turn over.
7. Repeat Steps 3-6.
8. Open the hulls.

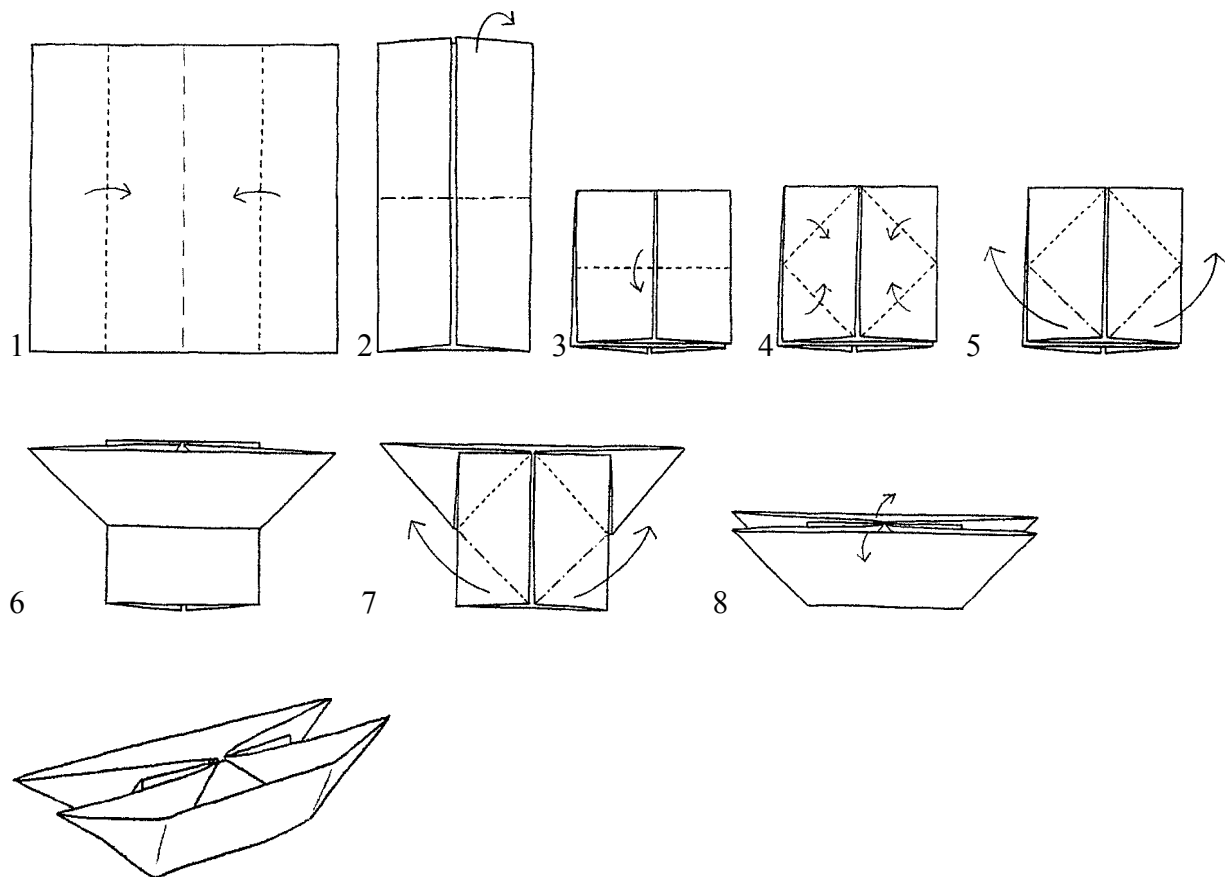

WINDMILL

This windmill actually works. Use it as you would with any other windmill (e.g. pin and a small bead).

9. Open the CATAMARAN.
10. Fold out two opposing ends.

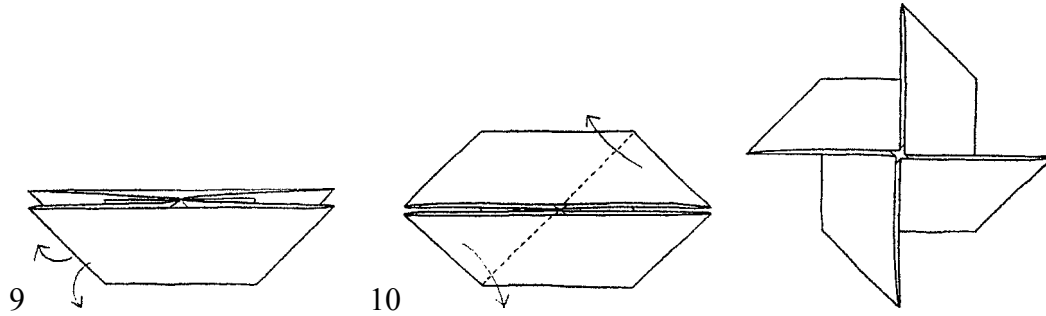

SAILBOAT, TRICK BOAT

11. Fold back the WINDMILL diagonally in half.
12. Fold up the front part to make a hull.
13. Now you have a sailboat.
14. Ask your friend to hold the tip of the sail (X) and close his/her eyes. Pull the hulls down. Now what is he/she holding?

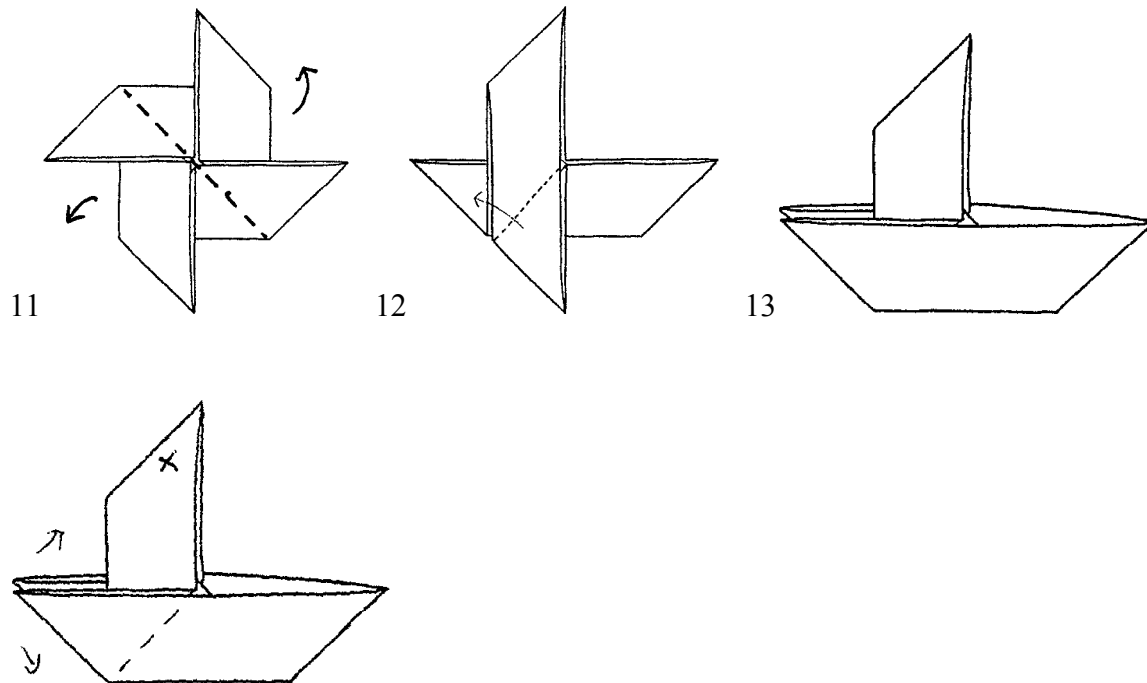

COASTER

This pattern starts with a CATAMARAN.

1. Make a CATAMARAN. Open and make it flat.
2. For each flap, make diagonal crease and open by sliding in a finger.
3. Now you have a large square with four small ones. On each small square, fold corners to center line.
4. Open each triangle fold. Press.

You may want to cut a small circle out of scrap paper and glue it on the center of the coaster so the pieces will stay down.

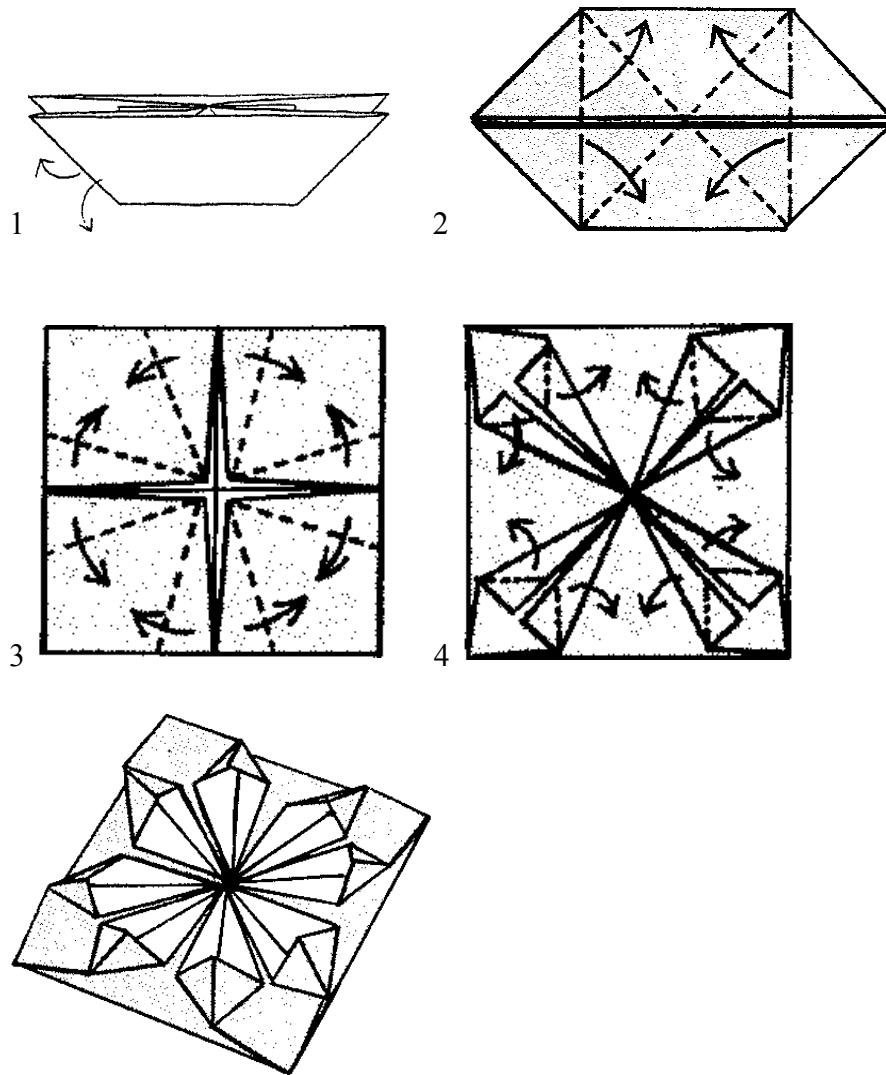

TREE

Make your forest with trees in different sizes and a few origami

animals.

1. Fold in half and unfold.
2. Fold left and right corners to center line.
3. Fold in corners.
4. Fold up the bottom.
5. Fold up one more time.
6. Fold down to make a trunk
7. Glue flaps that form the trunk of the tree. Turn over.

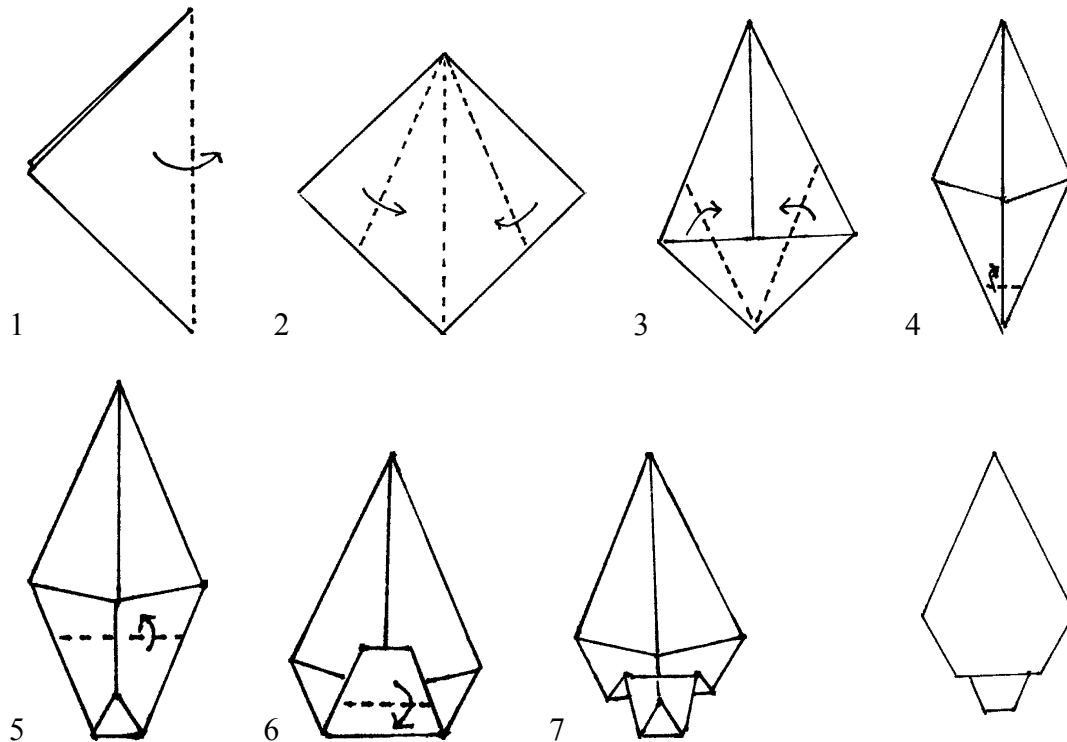
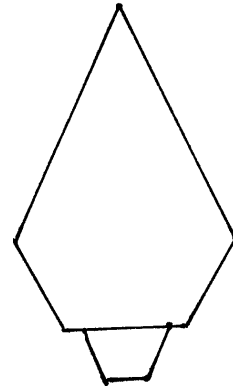

Greeting Card

Make an Earth Day or holiday greeting card. Attach one or more trees on a piece of card stock or folded paper. You can write your message directly on the tree or on the card.

Christmas Ornament

At Christmas time, decorate the tree with small pieces of paper, stickers, sequins, ribbon pieces and/or glitter glue. Attach a loop and hang on a Christmas tree or on a wall.

PECKING BIRD

As this bird pecks, it moves forward. Just gently tap its tail. Boys can race their birds across the tabletop. Boys can draw features like eyes and wings with markers or crayons.

1. Fold in half and unfold. Fold left and right corners to center line.
2. At halfway between **A** and **B**, fold slightly to mark the place (**C**).
3. Fold in half.
4. Crease by folding and unfolding. Do the same to the other side. You just made the fold line for the beak.
5. Open and fold the beak inside.

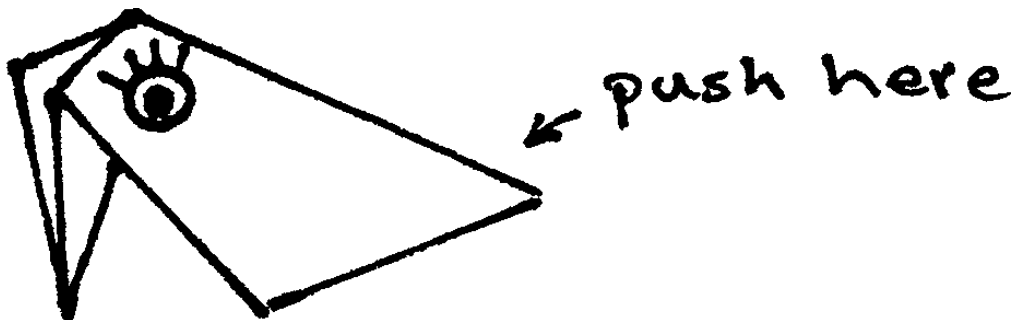
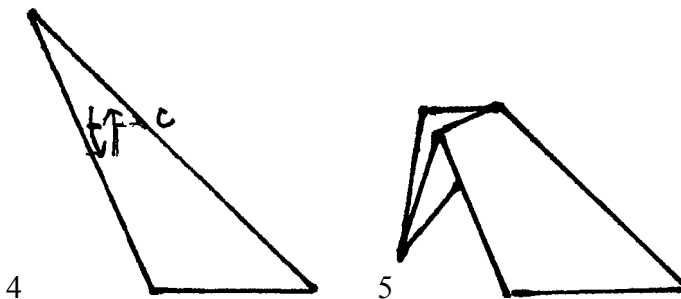
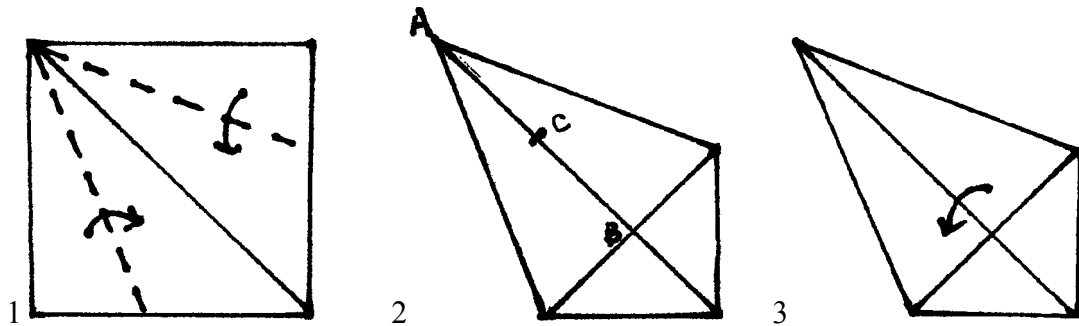

BUTTERFLY

1. If the paper has color only on one side, put the colored side down. Fold in half. Now the colored side is on the outside. Fold in half again.
2. Fold up a bottom corner. Do the same on the other side.
3. Fold the top flap down. Do the same on the other side.
4. Make a little pocket fold, folding **X** inside **P**.
5. Make a crease for the wings (dotted line between **A** and **B**). Cut from **C** to **B**.
6. Fold up the wings.
7. Press as shown and fold up the tail end on both sides.

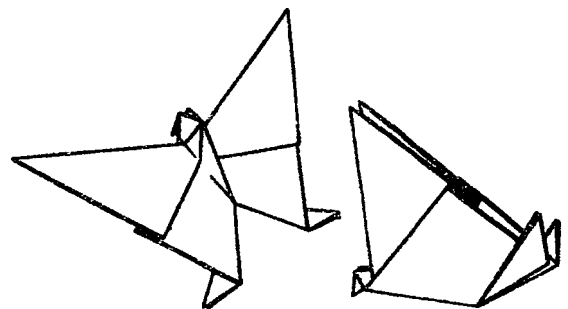
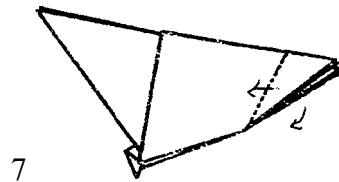
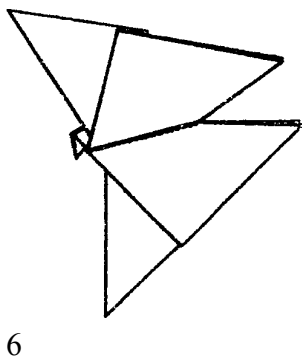
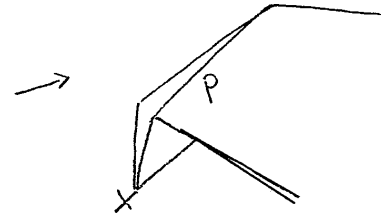
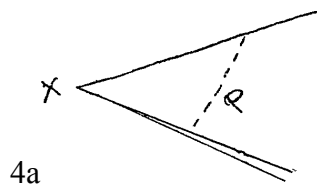
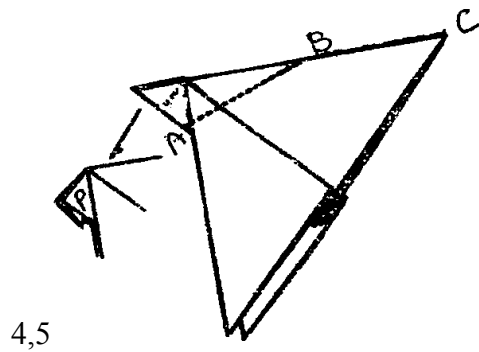
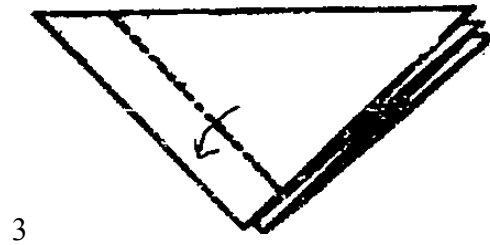
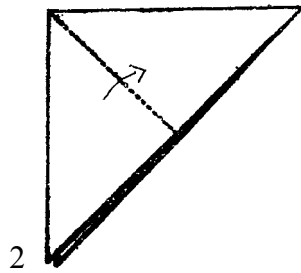
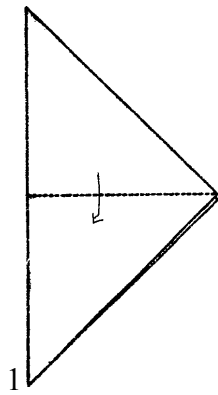

HOUSE

1. Fold paper in half.
2. Fold right and left quarters to middle.
3. Make a diagonal crease at a top corner. Stand the side, slide in a finger and open the side. Press flat.
4. Do the same on the other side.
5. Draw doors and windows.

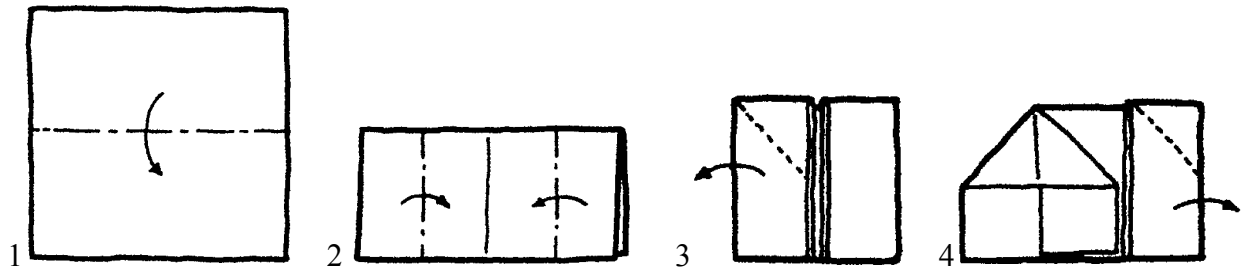
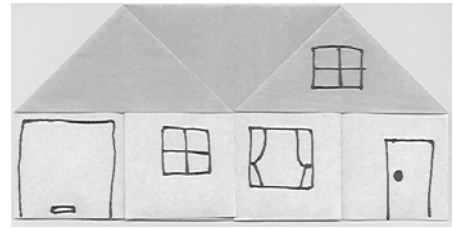

You can use square or rectangle paper. Fold rectangle sheet lengthwise first and see what kind of house you get. Now make another by folding widthwise first.

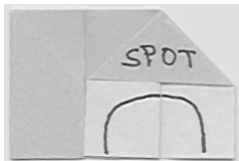

UPRIGHT PIANO

Start with Step 4 of the HOUSE.

5. Fold up the center flap.
6. Fold down the flap in third as shown.
7. Fold the side up. Bring down the "keyboard."

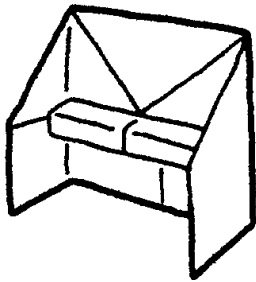
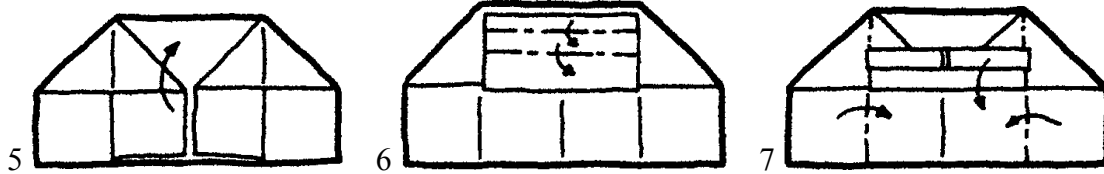

COIN PURSE (CANDY BAG), HAT

Start with Step 4 of the HOUSE.

5. Fold both sides toward back.
6. Fold up the flap by rolling 3 or 4 times. Do the same on the other side.
7. Now you have a coin purse or a candy bag.

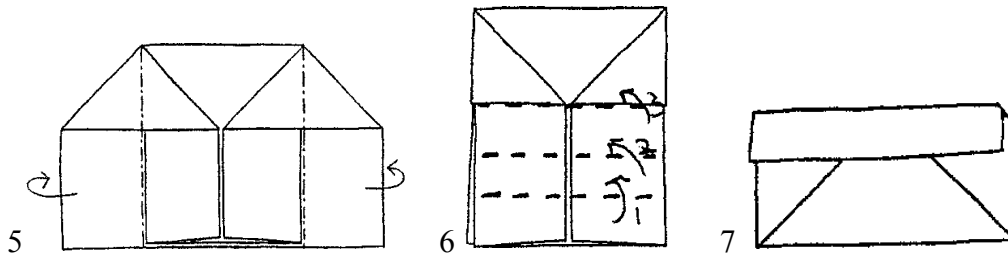

Make a bag using a large sheet of paper, like newspaper. Put it upside down. Depress the center a little. Now you have a hat!

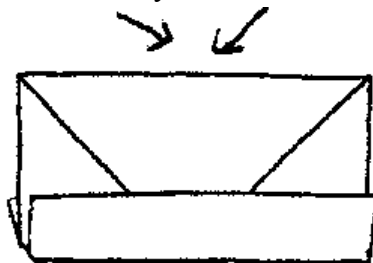

LANTERN

1. Fold in half and unfold. Fold the sides to center line.
2. Fold down four corners.
3. It should look like this. Turn over.
4. Fold ends toward center.
5. Fold four corners toward back.
6. Open the ends.
7. Press the ends.

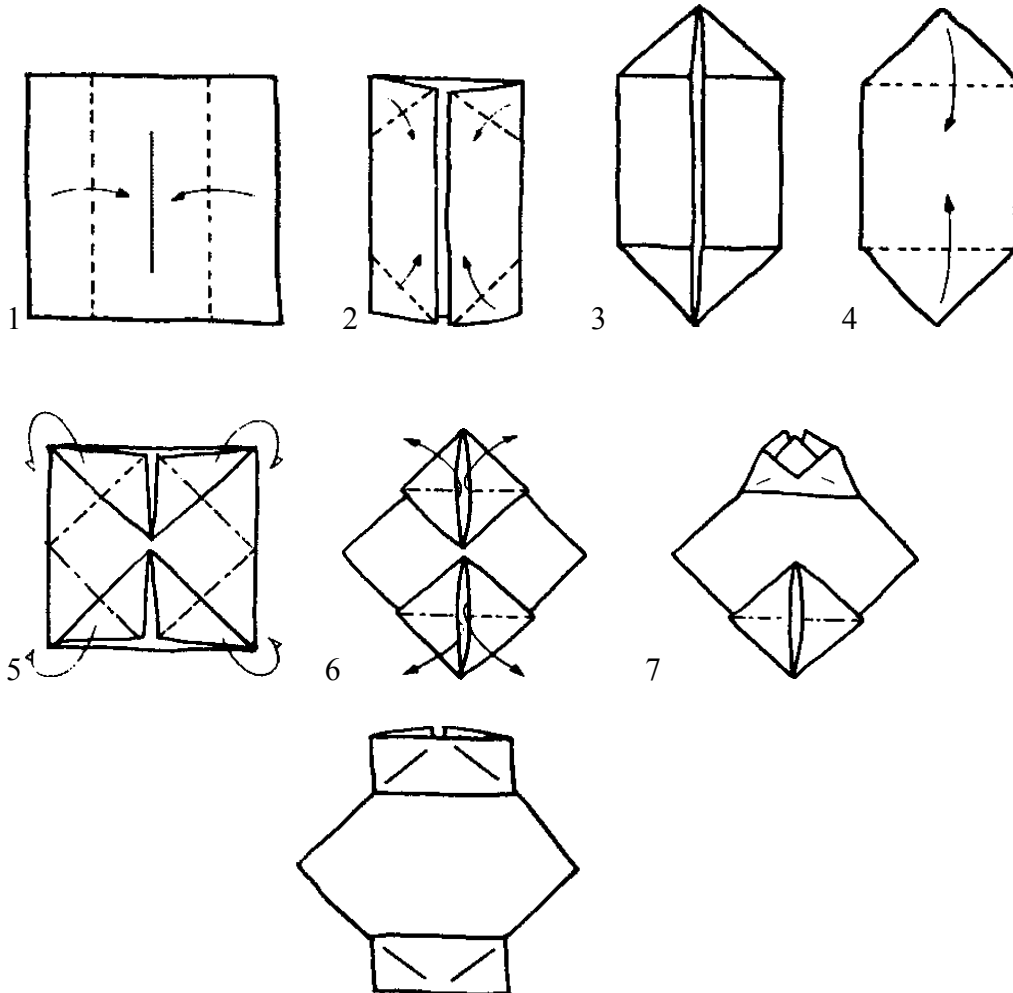

ROWBOAT

Float this boat on water and blow on it.

1. Fold in half and unfold. Fold the sides to center line.
2. Fold down corners.
3. Fold the corners one more time.
4. Fold in the sides.
5. Open from the middle.
6. Turn the boat inside out.

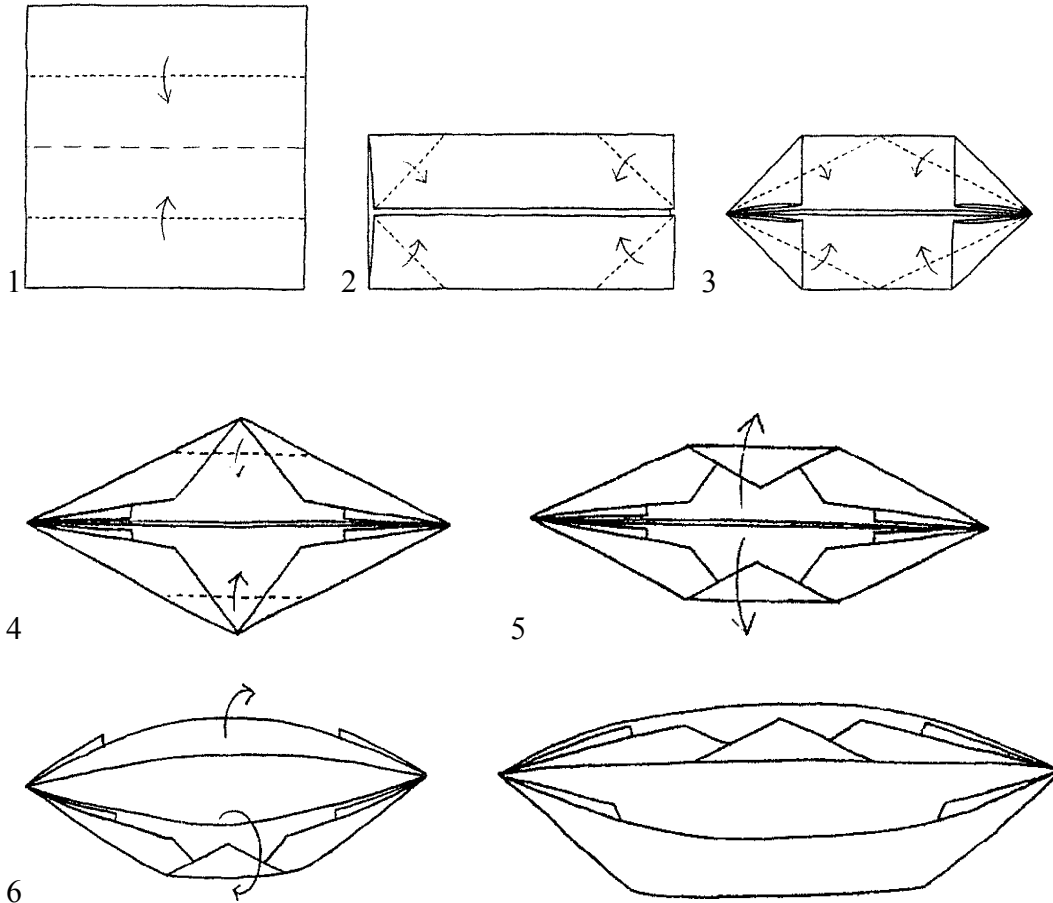

BALLOON

Put this paper balloon with the palm of your hand. How long can you keep it in the air?

1. Fold in half.
2. Fold in half again. Now you have a square.
3. Slide your finger inside top flap. Open and flatten to form triangle.
4. It should look like this. Turn over.
5. Fold up the remaining square. Slide your finger and open and flatten as in Step 3.
6. Fold up the corners of top layer.
7. Fold left and right corners to center line.
8. Fold top corners down
9. Slide small triangle areas into slots.
10. It should look like this. Turn over and repeat Steps 6-9.
11. Inflate by blowing at bottom.

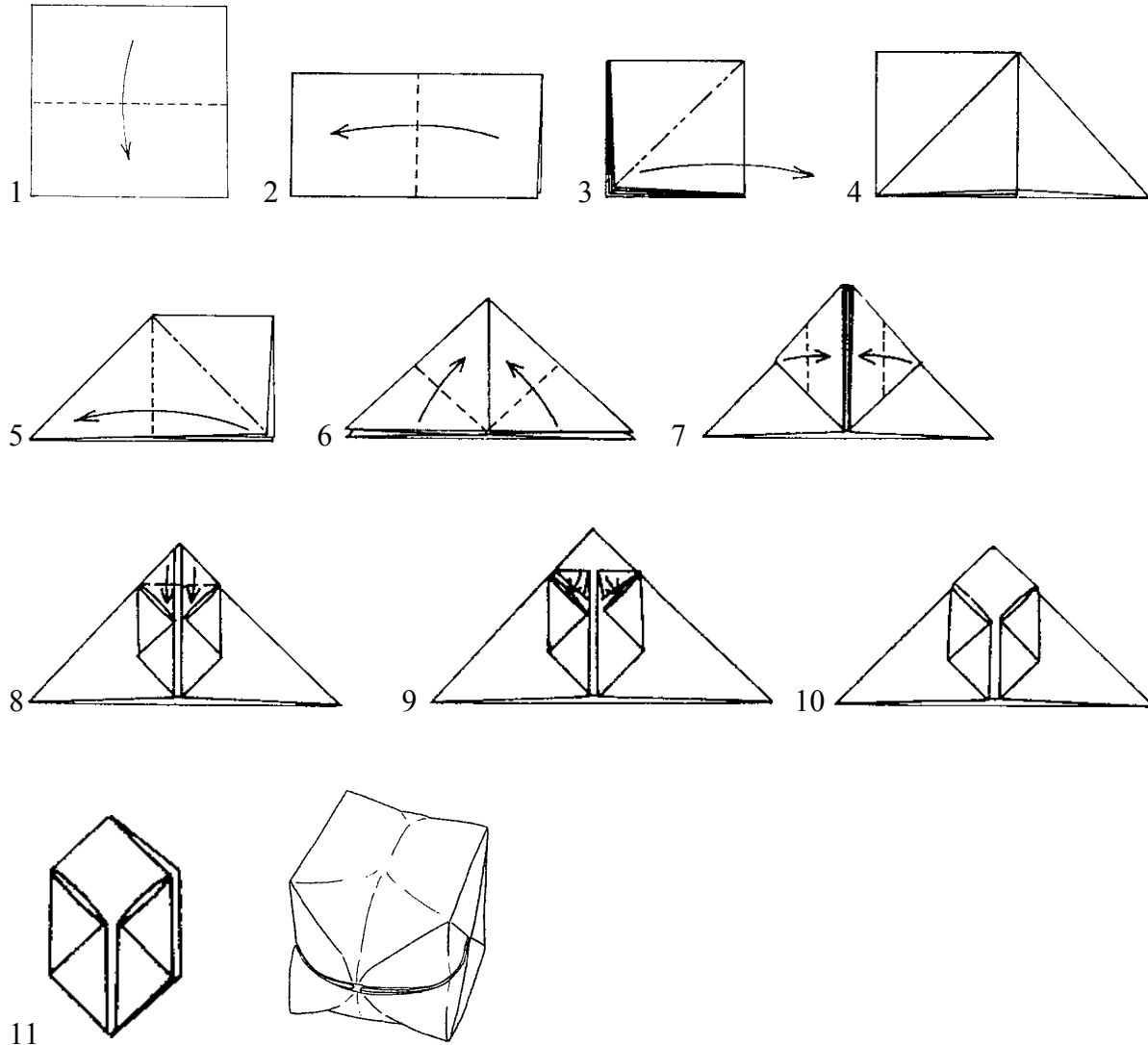

Place a marble inside and roll it down a slope. Fill it with water and make a water balloon.

MYSTERY TRIANGLE

Hold the triangle closed and place it on a flat surface. Release it gently. Wait a moment and it will stand up on its own!

One end of the triangle will be bulky. Make sure you press well at each step. You are repeating the same series of folds to give weight on one side.

1. Fold in half. Unfold.
2. Fold left and right corners to center line.
3. Fold up bottom triangle.
4. Fold corners to center line.
5. Fold up bottom to create a triangle.
6. Fold corners to center line.
7. It should look like this.
8. Fold in half. Press.

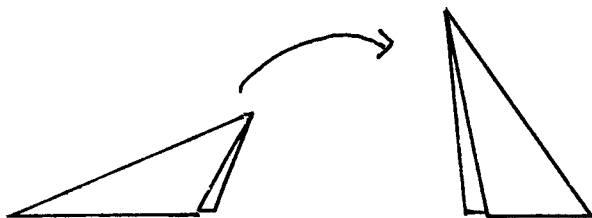
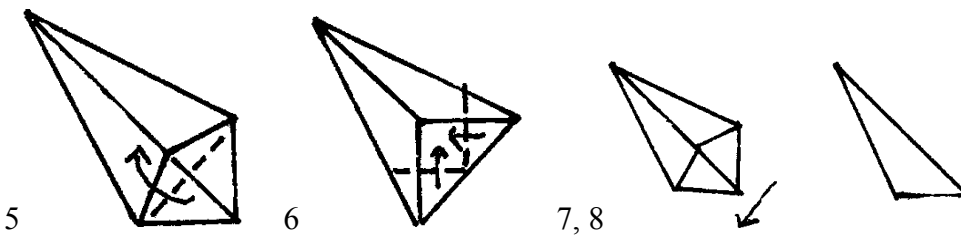
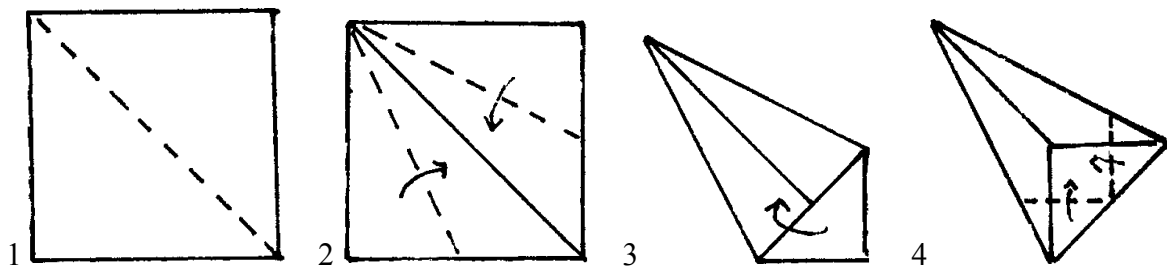

CUP

Use this for water or a scoop of ice cream.

White copying paper or butcher paper works well.

Make sure you dispose of the used cup properly.

1. Fold the paper in half.
2. Fold one corner over to the other side.
3. Do the same for the other corner.
4. Fold down the top front flap.
5. Turn the cup over and fold down the other top flap.

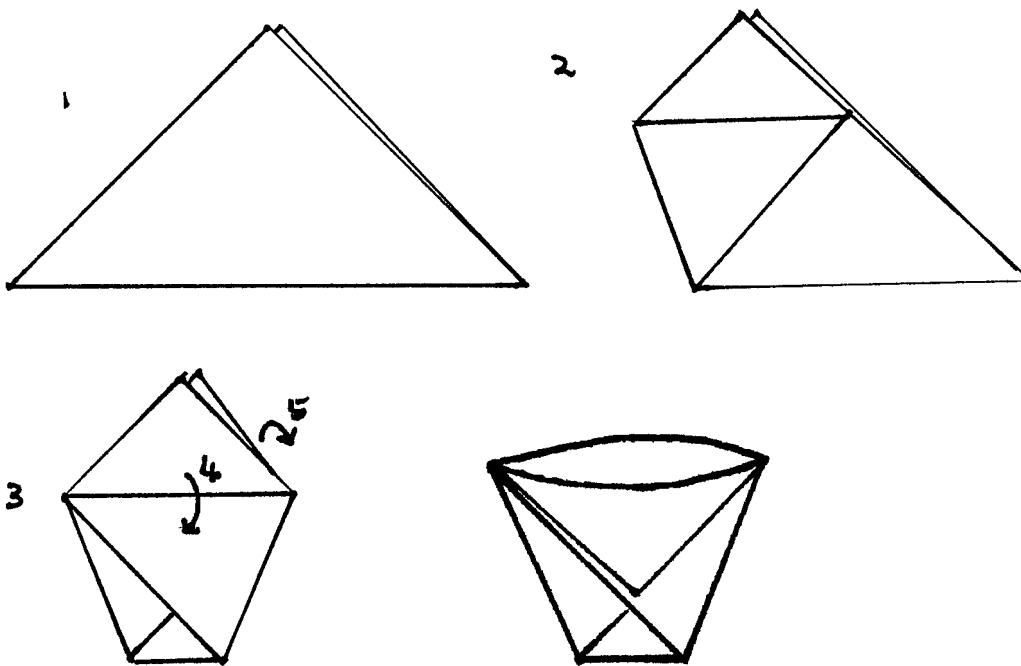

BOX

You can make your own box with a lid. Use many sheets, each slightly smaller, and you can have a box within a box within a box within a box.....!

1. Determine the center of the paper by folding into a quarter size square. Fold in all four corners to the center.
2. Fold left and right side to center line.
3. Fold top and bottom to center line.
4. Open so that only left and right corners are folded in.
5. Stand the sides.
6. Fold in one end using the creases created in previous steps.
7. Do the same for the remaining end.

To make a lid, fold in slightly less in Steps 2 and 3.

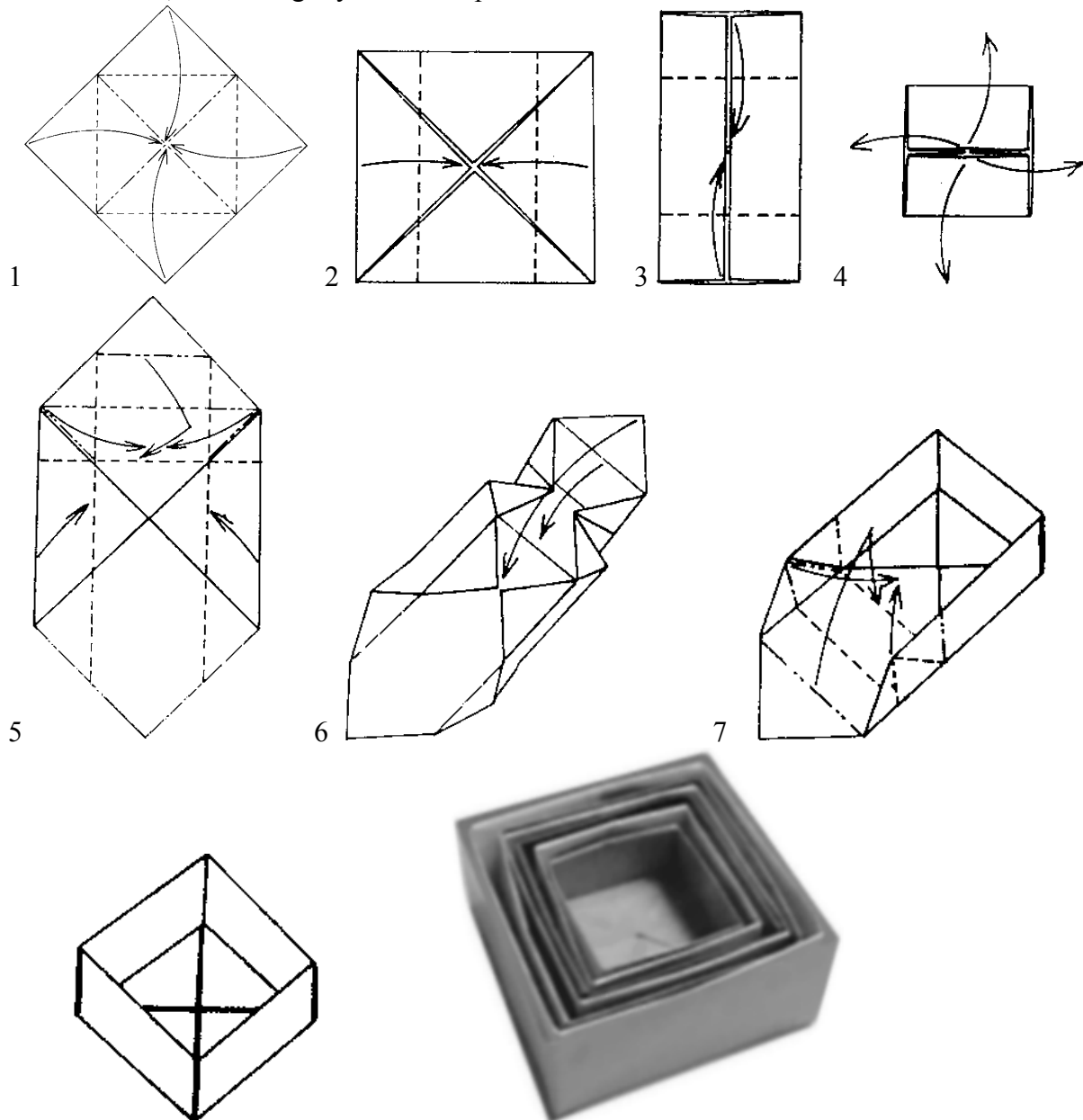

CANDY DISH/NUT CUP

You may want to use a sheet that has different colors on each side or use two single sided sheets back to back.

1. Fold in half.
2. Fold in half again.
3. Slide a finger in and open one triangle.
4. Press. Turn over.
5. Stand the remaining triangle and open it. Press.
6. Fold down the corners of the top layer to center line.
7. Open small triangles. Press.
8. Reverse the fold. Now you see half of the result created in Step 7.
9. Turn over and repeat Steps 6-8.
10. Bring down four tops of the box.
11. Gently open the box.

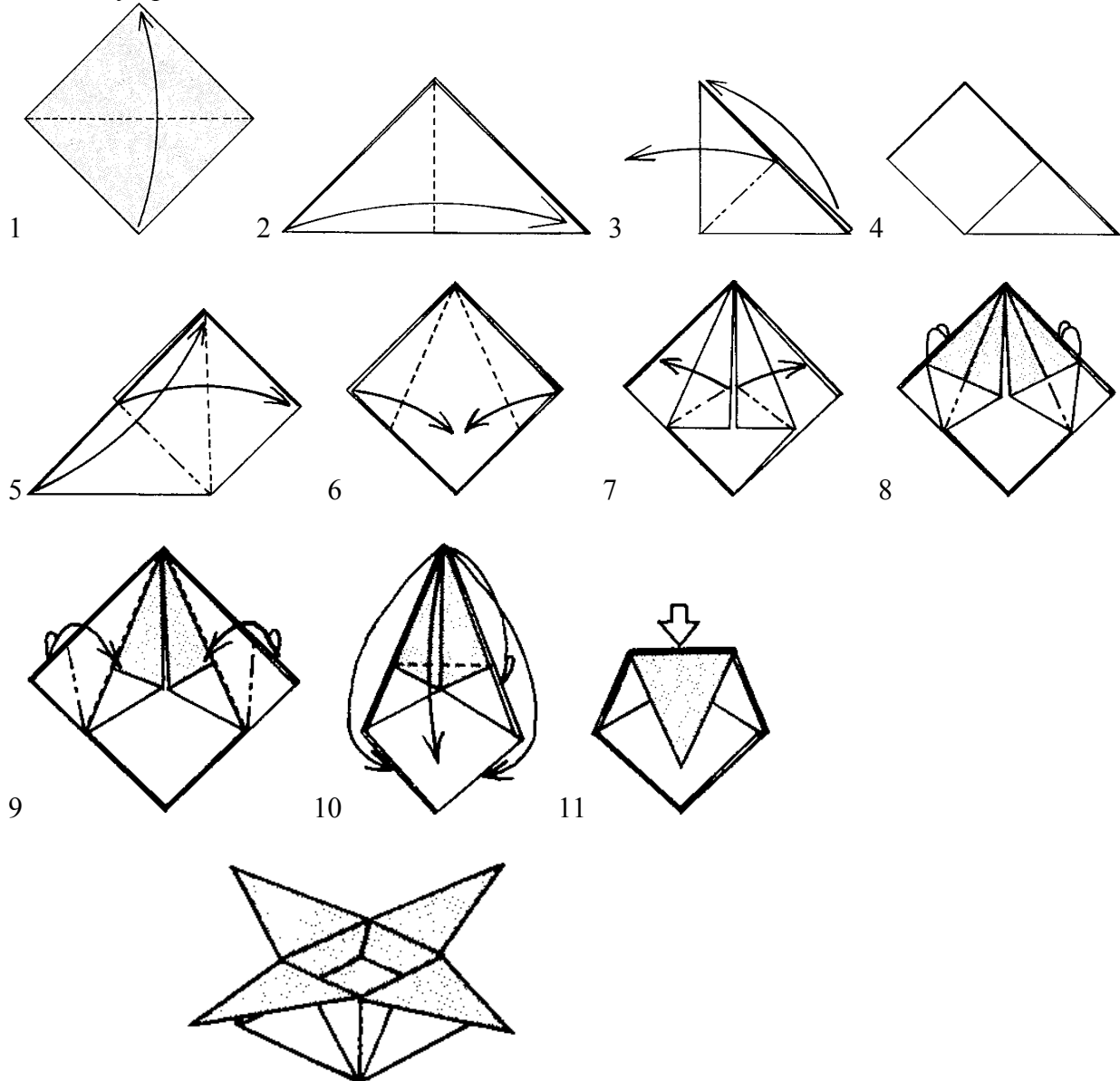

STAR

This is really pretty if you use double sided paper or use two one sided sheets back to back.

1. Determine the center of the paper by folding into a quarter size square. Fold in all four corners to the center.
2. Fold in half forming a triangle.
3. Fold in half again.
4. Slide your finger in the top triangle and open it into a square. Press. Do the same on the other side. Now you have square.
5. Make crease lines as shown.
6. Gently open the square. You now have an elongated diamond shape. Turn over and repeat Steps 5 and 6.
7. Fold down two top parts. Hold onto the two inside pieces and gently pull straight out. Voila, you have a star!

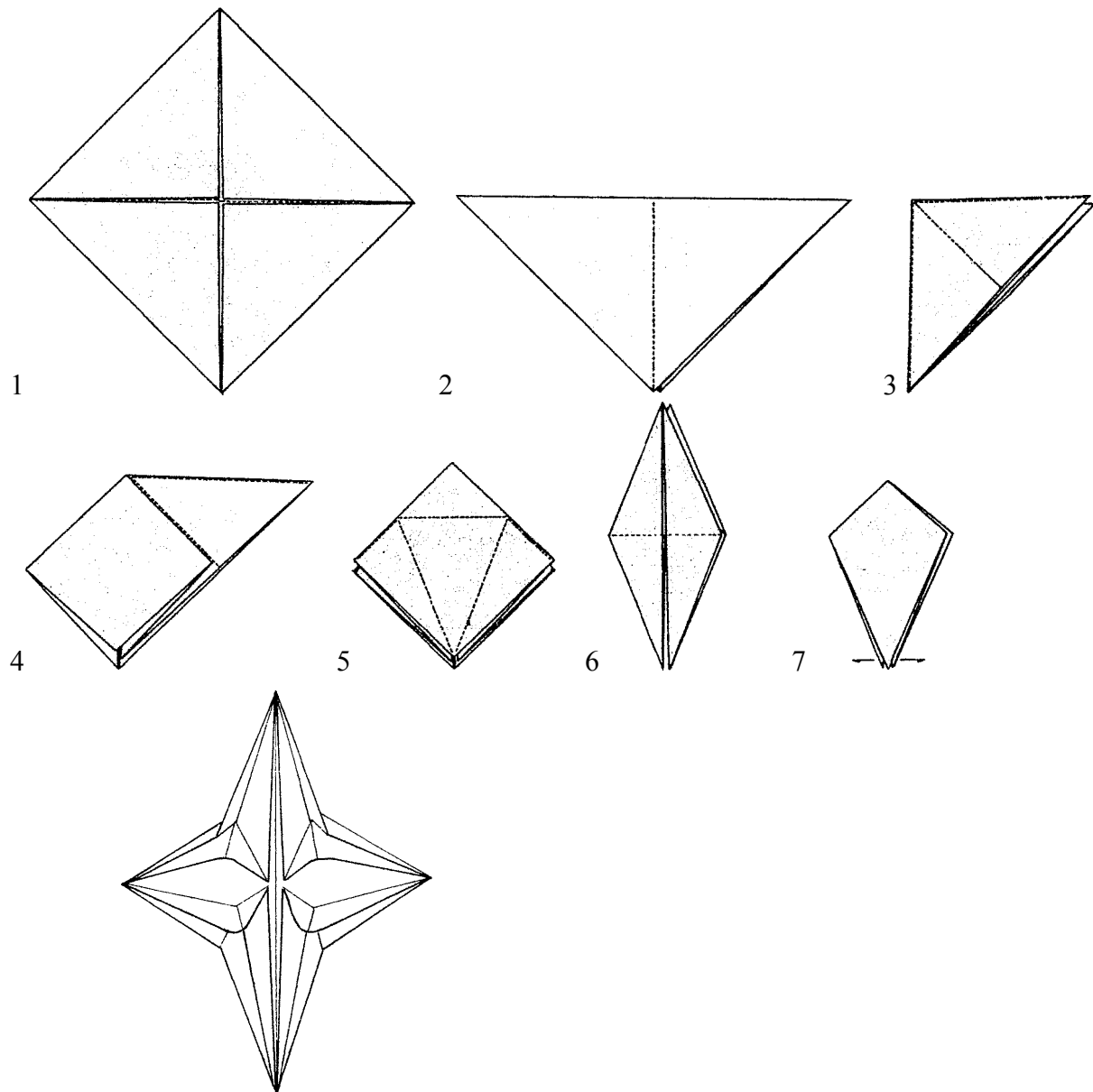

BOBCAT TRAIL GAME

SCOUTING
Lord Baden-Powell founded Boy Scouting.

S
Say the Cub Scout Promise.
I, _____, promise to do my best
To do my duty to God and my country,
To help other people, and
To obey the Law of the Pack.

Fun
Give the Cub Scout Salute.
Tell what it means.
The Cub Scout gives goodwill!
The Cub Scout grows the pack go.
The Cub Scout helps the pack go.
The Cub Scout follows Akela.
The Cub Scout helps the Law of the Pack.
Say the Law of the Pack.

GREAT
Tell what Webelos means.
Webelos means:
W - Webelos
E - Enthusiasm
L - Loyalty
O - Obedience
S - Skill
O - Outdoor Activities

1
Show the Cub Scout Sign.
Tell what it means.

2
Show the Cub Scout Handshake.
Tell what it means.

3
Say the Cub Scout Motto.
DO YOUR BEST

4
Tell what it means.

BOBCAT TRAIL GAME

1. Cut out square along dotted line.

2. Fold into quarters. Then open and flatten out.

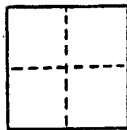

3. Fold the corners to the center.

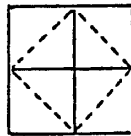

4. Turn over, and again fold corners to the center.

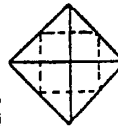

5. Turn back to first side. It will look like this



6. Put thumbs and index fingers into pockets to play the game.

JUMPING FROG

Have a den or pack frog-jumping contest.

Use an index card for each frog. 4 x 6 cards are easier for younger boys than 3 x 5 cards.

For each fold, make sure you crease well.

1. Fold down right top corner. Unfold.
2. Fold down left top corner. Unfold.
3. Fold backward as shown by dotted line. Unfold.
4. Push down at the center of "X" and bring sides to meet in the middle.
5. Push down top triangle.
6. Fold up two points of the top triangle.
7. Fold sides of card to the center.
8. Bring the bottom edge up almost to the top and fold.
9. Fold down top layer.
10. Turn over. You may want to draw eyes.

Stroke the back of frog to make him jump.

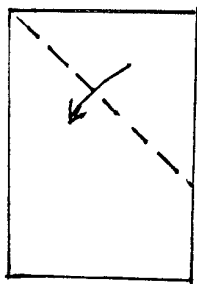

1

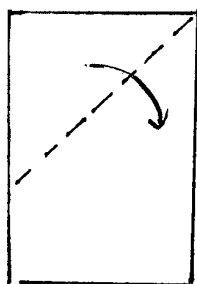

2

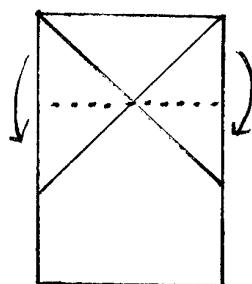

3

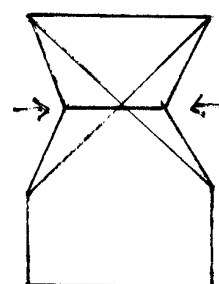

4

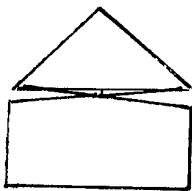

5

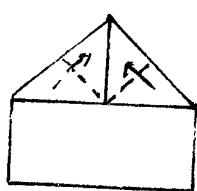

6

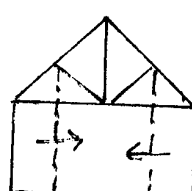

7



8



9

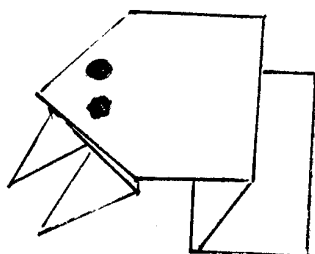

MAGIC BOOK

Create a little 8-page book from one piece of paper, without staples or other bindery!

An 18x24 sheet of paper will make a 9x6 book. The boys can make mini books from typing paper as well. They can write about themselves or draw pictures.

1. Fold a rectangle sheet of paper into half, lengthwise. Crease well. Open
2. Fold the paper into half the other way.
3. Bring each end to the center fold.
4. Cut from the center fold to the middle fold.
5. Open as shown.
6. Fold it like a book.

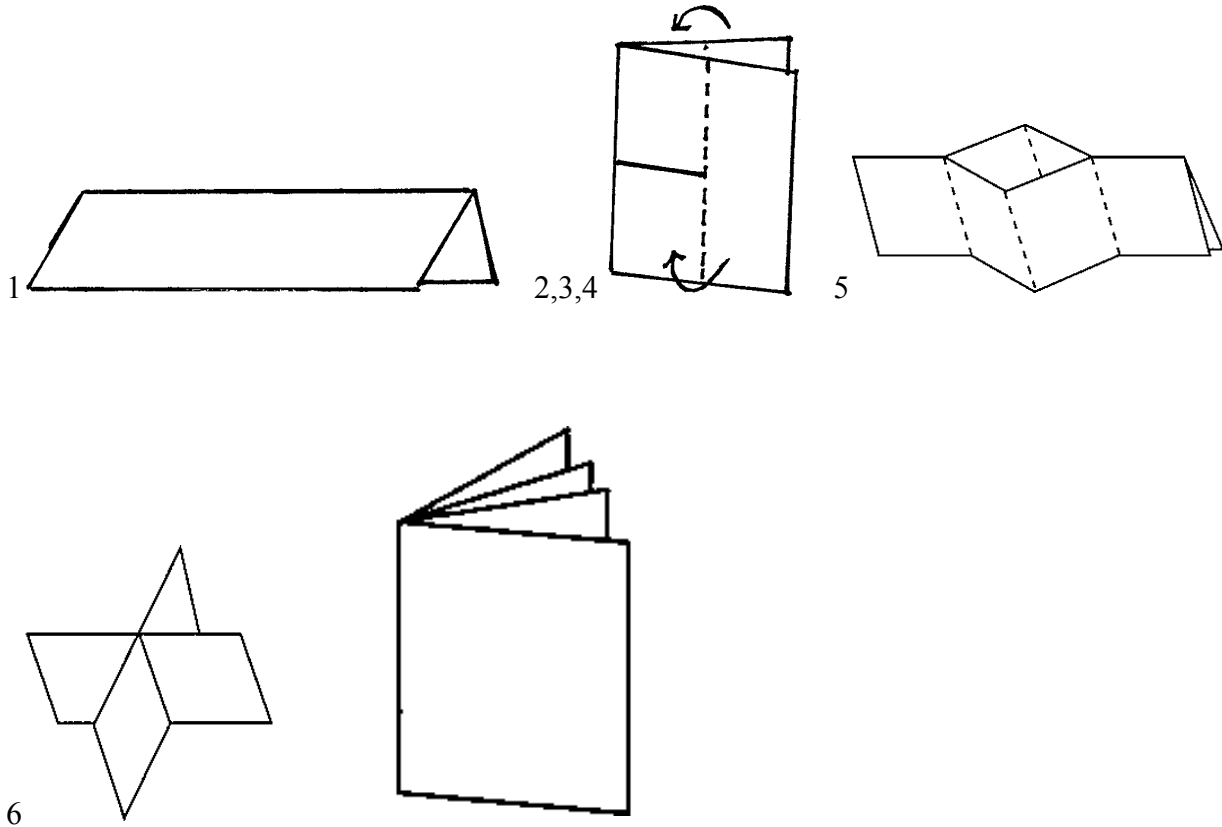

SHIRT

Start with a rectangular piece of paper. A dollar bill or a bill of any denomination will work, or a rectangle in the ratio 2.5 by 6 (e.g. 3.5"x8.5" or 4.25"x10").

1. Place the colored side of the paper down. Fold in half and open it up again.
2. Fold each edge in to the centerline.
3. Turn it over. Fold about ½" along one of the narrow edges. This is going to be the collar.
4. Turn it over. Fold each corner of the collar to the centerline. Now the collar is finished.
5. Fold the other end a little less than a third way. Open again.
6. Unfold and tuck the bottom end inside as shown.
7. Fold out a bottom into a triangle. This is a sleeve. Fold the other sleeve.
8. Fold the bottom to the collar.

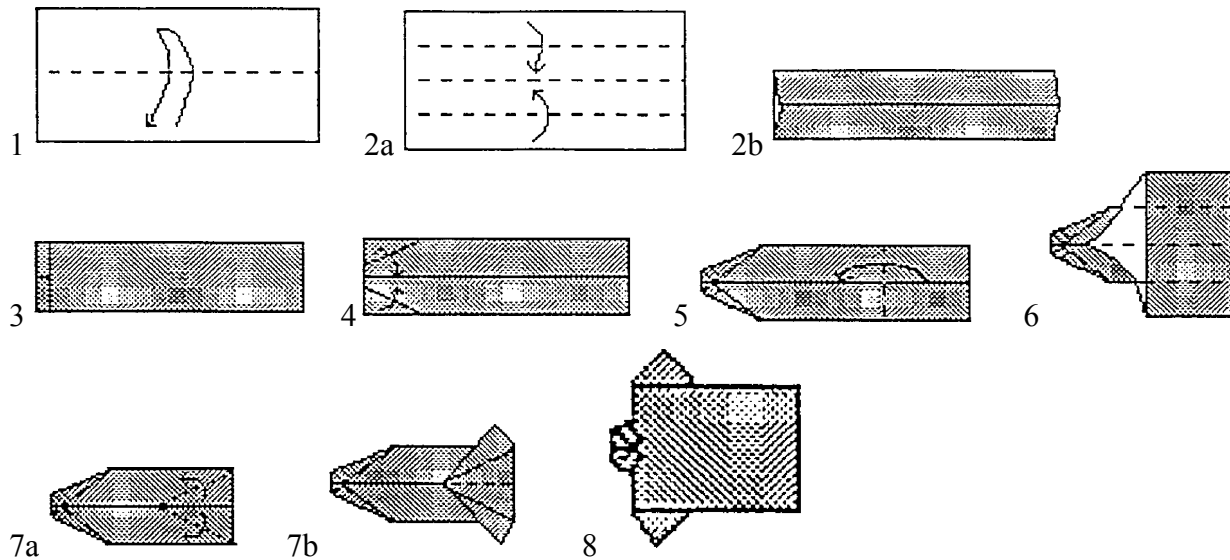

Aloha Shirt Place Card

Great for 2007 Blue and Gold Banquet (Aloha Cub Scout).

Use 5"x12" piece of wrapping paper. Pastel patterns works best.

Write a name with a dark permanent marker.

Greeting card

5"x12" rectangle works well for a greeting card.

You may wish to decorate it with a tie for a card to a male and buttons, lace, etc. for a card to a female.

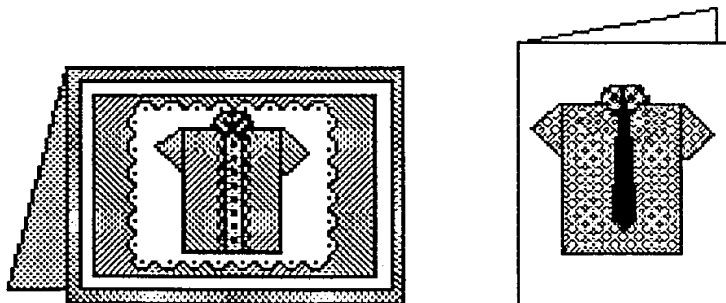

(Idea and drawing from RAFT handout)

KIMONO

Use a rectangle in the ratio 1:3. This instruction is for a sheet of 3.75"x11" paper.

Use printed or patterned paper.

1. Place the paper with the printed side down. Fold the top down $\frac{1}{4}$ " then fold down again over the first fold. This will form the collar.
2. Fold the strip in half lengthwise, creasing only the top 2"-3". Unfold. Turn over.
3. With the printed side up, fold the top corners to the middle line, thus forming the collar of the kimono. (The wrong side of the paper will be showing next to the collar.)
4. Fold the long strip back about 1" below the end of the collar. (This will be the bottom of the kimono.)
5. Fold the strip forward so it meets the bottom of the kimono.
6. Fold the sides in toward the center, making sure that they touch the edges of the collar.
7. Open out each layer that was just folded to the middle. Push down at the top so a triangle is formed at the top.
8. Fold the top back, leaving the point of the collar showing. (This is the top of the sleeve.)
9. Turn the kimono over and fold the back flap up to the top of the sleeve. Add a strip of color for the obi, using a ribbon or coordinating paper strip.

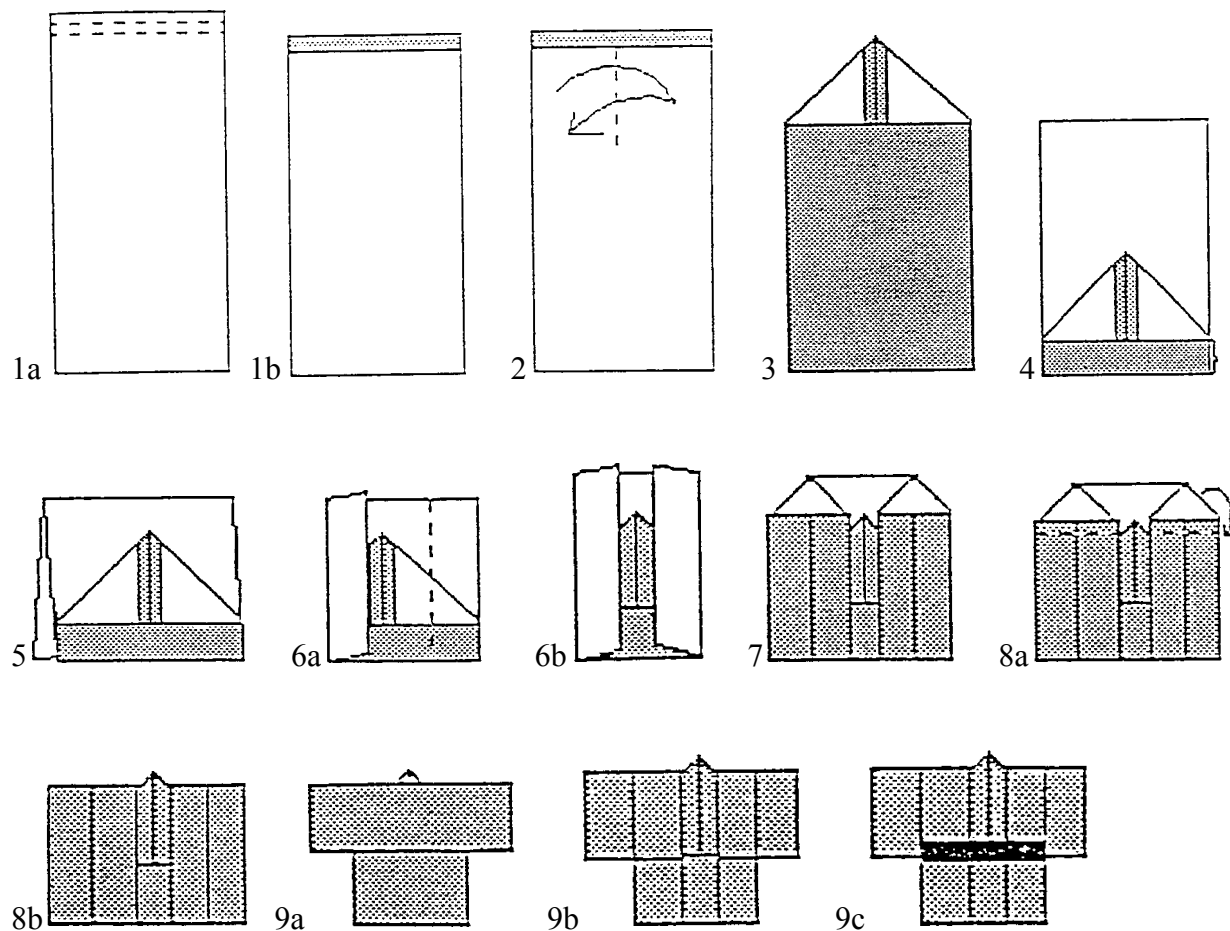

(Instruction and illustration from RAFT handout)

CHINESE LUCKY STAR

A star has five points. Five is a lucky number in Chinese tradition. They represent five kinds of happiness—goodness, prosperity, longevity, propriety and health.

You can make these stars with strips of paper. At the time when tractor feed computer paper was used, some people used perforation strips. The width does not matter. I have made huge ones with 3" and tiny ones with 3/16" strips. 1/2" is easy to work with. Good length for a 1/2" strip is about 10" but it depends on the thickness of the paper. Make some using copying paper first. Then make strips from old calendar pages, wrapping paper, magazine pages, etc.

Some people write short messages on the strips before they make them into stars. I know a Scoutmaster who received a jar with many stars, each with a special message.

1. Make an overhand knot. Make sure the fold is nice and tight.
2. Snip the short end if it is too long so it will fit in the knot. Tuck it in the knot.
3. Start folding the long end over the knot, keeping the shape of pentagon. (If you follow the shape, it will naturally guide you where to place the next fold.)
4. Continue wrapping.
5. Tuck in the end of the tail. You may have to snip a little to fit it in the pentagon.
6. Now you have a multi-layered pentagon. It should be slightly puffy, not too flat.
7. Hold the pentagon between two fingers. With a thumbnail of the other hand, gently push at the center of one side. Repeat on all five sides to form a puffy star.

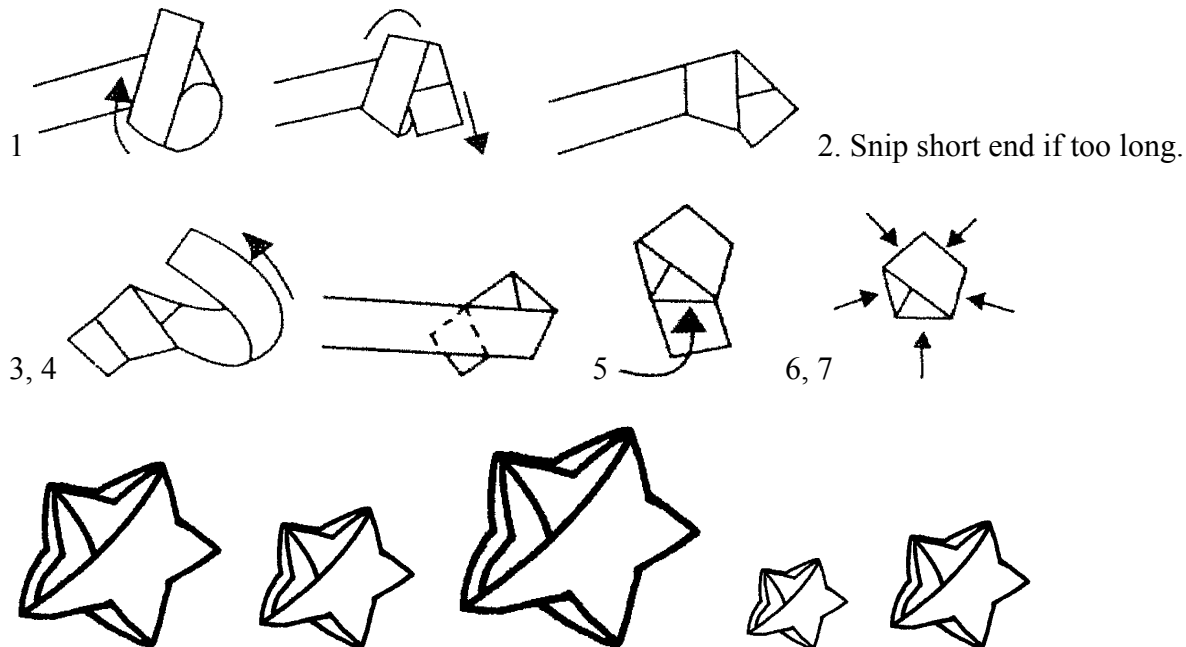

Stars in a Jar

Make many stars using strips of different colors and sizes. Place them in a clear glass jar.

Star Necklace or Garland

With a needle and thread, string stars and beads to make a necklace. String a lot of stars and make a garland.

PUFFY HEART

Strips the size of $\frac{3}{4}$ "x5" to 1.5"x10" will be easiest to work with.

1. Start folding the strip into a triangle as you would fold a US flag.
2. Keep folding.
3. Cut the end so that it can be tucked into the triangle.
4. Hold the triangle between two fingers. With a thumbnail of the other hand, gently push the longest edge to make it puffy.
5. Press the two pointed ends flat. Cut off the tip. If the heart is small, you don't need to make a nice round edge. It will look like a heart even if the edge is cut straight.

